

Honeywell

T7516A,B,C Energy Management System



USER'S GUIDE

Weekday/Weekend 7-day Programmable
Heat and/or Cool Conventional
and Heat Pump



69-1154-1

Welcome to the world of comfort and energy savings with your new Honeywell T7516A,B,C Energy Management Thermostat brought to you by Gulf Power Company. This thermostat allows up to seven separate days of programming. You can set the thermostat to control the temperature in your home, your water heater, and another appliance (such as a swimming pool pump) according to your personal schedule and preferences. This thermostat keeps you comfortable, and saves you energy.

Besides being programmable, this thermostat contains a communications module that allows Gulf Power to communicate with your thermostat so you can take advantage of *Residential Service Variable Price (RSVP) Rate*, which is part of the GoodCents Select® program.

Residential Service Variable Price (RSVP) Rate. The T7516A,B,C Energy Management Thermostat informs you of the energy price in effect at any given time (see Fig. 1). A special feature of this thermostat allows you to program it to automatically adjust your energy use for each price. These prices are: Low (least expensive), Medium, High, and Critical (most expensive). The thermostat also provides you with the ability to operate your electric water heater and another appliance based on the price in effect.

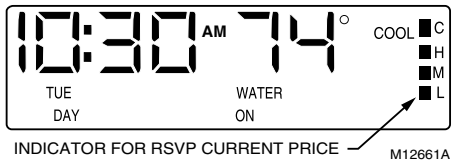

Fig. 1. RSVP Rate indications.

Table of Contents

Getting to Know Your Thermostat	6
Standard Display	6
Keypad	8
Battery Compartment	8
Replacing Thermostat Batteries	8
Indicator Light	10
Programming Overview	10
User Operations	10
Present Setting	10
Overrides	12
Hold	12
Temporary	13
Recovery From Setback	14
Programming Your Thermostat	15
Price Response	17
Entering Schedule Programming	18
Inputting Basic Program	19
Changing Parts of the Program	39

Programming Price Response	48
Overview	48
Entering Price Response Programming	50
Controlling Heat/Cool System	59
Changing the System Setting	59
Controlling Fan	60
Troubleshooting	61
Personal Programming Charts	66
Customer Assistance	71
Warranty	71

Getting to Know Your Thermostat

The thermostat has a display, a covered 15 key keypad, a covered battery compartment, and an indicator light on the front panel (see Fig. 2). Fig. 2 shows the thermostat, display, and all display segments.

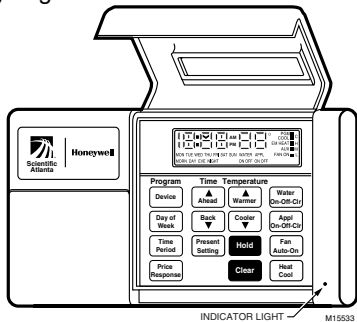
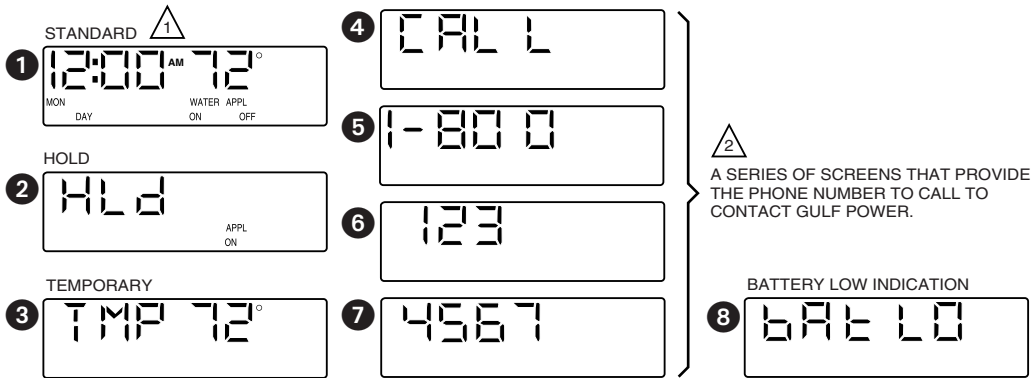

Fig. 2. T7516 Energy Management Thermostat.

Standard Display

The current room temperature and time are always part of the standard display. Other displayed data includes heating and air conditioning (Heat/Cool) status, day of the week, schedule period, water heater and appliance status, and the RSVP current price (see Fig. 2). The thermostat display automatically sequences several displays (see Fig. 3).

NOTE: The colon in the time display blinks, except when in the programming mode.



¹ THIS SCREEN IS ALWAYS PART OF THE DISPLAY SEQUENCE.

² ONLY APPEARS: WHEN GULF POWER SIGNALS IT TO DO SO; DURING A LOSS OF COMMUNICATION, OR A THERMOSTAT FAULT.

Fig. 3. Display sequence.

M12660B

Keypad

Lift the front cover to see the keypad. From the keypad, you can operate and program the thermostat. To operate the thermostat, press and release the keys.

NOTE: The thermostat registers all programming inputs immediately and maintains them until manually changed. Low batteries or power outages do not delete thermostat programming.

Battery Compartment

The battery compartment under the left side of the front panel contains two AA batteries that keep the clock running during a power interruption.

Replacing Thermostat Batteries **IMPORTANT**

Install batteries to maintain the time in the event of a power loss. Although the thermostat has a low battery indicator, replace the batteries once every two years to prevent the thermostat from losing the time during a momentary power loss.

NOTE: If the time is ever incorrect, you can not change it. Gulf Power periodically updates the clock to the correct time.

As the batteries run low, the thermostat display sequence includes an indication of this. The low battery indication appears one to two months before the batteries run out completely. Replace the batteries as soon as possible after the indication appears.

You need two AA alkaline batteries (not supplied); non-alkaline batteries do not last as long, and can leak, damaging the thermostat or wall surface. To replace the batteries:

1. Use a coin to carefully remove the battery door (see Fig. 4).
2. Follow the directions on the label revealed by removal of the battery door.

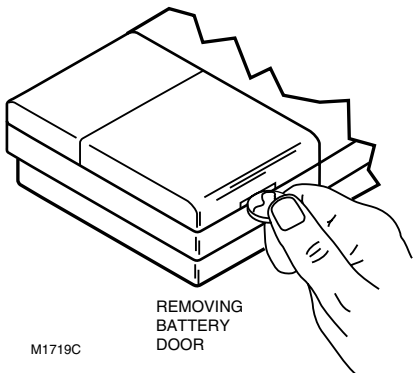

Fig. 4. Battery Door Removal.

Indicator Light

This light indicates primarily the emergency heat (or auxiliary heat). It also indicates whether Critical Time-of-Use Pricing is in effect, or is scheduled (see Table 1).

When the light is off, the emergency heat (or auxiliary heat) is off.

When the light is on, the emergency heat (or auxiliary heat) is on.

Table 1. Critical RSVP Price Indications.

Auxiliary (or Emergency) Heat	Indicator Light	Critical RSVP Price
Off	Flashes three times, then pauses.	In effect.
	Flashes once, then pauses.	Scheduled to start within 30 min.
On ¹	Flashes twice, then remains on.	In effect.
	Periodically turns off once.	Scheduled to start within 30 min.

¹Heat pump thermostats *only*.

Programming Overview

Complete the Personal Programming Charts (Tables 3 through 6) before you program your thermostat.

You can program the thermostat with separate schedules for heat, cool, electric water heater, and one appliance (such as a pool pump). Each device schedule is for seven separate days and up to four periods. For convenience, you can program the seven days individually, or simultaneously in any one of the following groupings: Monday through Sunday, Monday through Friday, or Saturday and Sunday. The four periods are: Morning (MORN), Day (DAY), Evening (EVE), and Night (NIGHT).

User Operations

Present Setting

Press and release the *Present Setting* key to return to standard display from any other display. The display first switches to show the current settings. After a few seconds the thermostat returns to the standard display.

NOTE: If the heating and cooling are both off, the display will show *Set - -*.



CAUTION

Equipment Damage Hazard.
Use of sharp fingernails or pencil points can damage the keypad beyond repair.

Use the ball of your finger or a soft pencil eraser when pressing the keys.

Overrides

An *override* is a setting used to manually change the setting without affecting the program memory.

From the standard display, press the *Clear* key to clear any temperature override in effect.

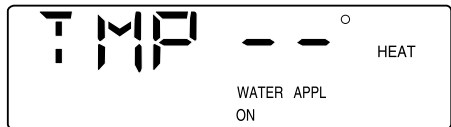

M15508

To clear *Water* or *Appliance* overrides, press the *Water* or *Appl* key until the display shows neither *On* nor *Off* underneath *Water* or *Appl*.

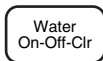

M15470

or

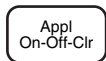

M15471

Hold

A *hold* is a setting used to override the program for an extended period of time. A *hold* maintains a setting until manually changed.

The hold display indicates all items currently set on hold.

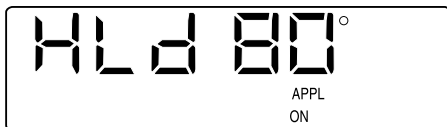

M15505

Press and release the *Hold* key to get to the hold display. Modifying any item being permanently held (with *Warmer*, *Cooler*, *Water*, and *Appl* keys) also brings up the hold display. Press *Warmer* or *Cooler* keys with hold displayed to increase or decrease the setpoint.

Press *Water* or *Appl* keys to toggle the hold status.

Water switches between: no hold and hold off.

Appl cycles through: no hold, hold on, hold off, and back to no hold.

NOTES:

- Only items being held appear on the display.
- *Water* cannot be permanently held on, but it can be permanently held off.
- With no temperature displayed, no hold exists.

Temporary

A *temporary* is a setting used to override the program for a brief period of time. Temporary settings maintain a setting until either the

RSVP Price changes to Critical, or the thermostat enters the next scheduled period.

The temporary display indicates the items set on temporary.

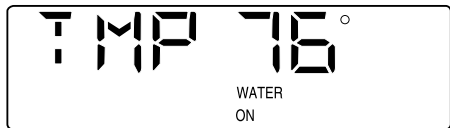

M15506

From the standard display, press the *Warmer* or *Cooler* key to get to the temporary display. Use these keys to increase or decrease the room temperature setting.

Press *Water* or *Appl* keys to display the temporary display and toggle the water or appliance state.

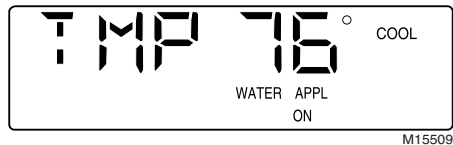

NOTES:

- A *temporary* cannot clear or replace a *hold*.
- With a *hold* in effect, an attempt to set a *temporary* changes the display to the *hold* display.
- Only items being held appear on the display.

- In spite of period changes, a *temporary* Water override, by default, lasts for one hour.
- With no temperature displayed, no *temporary* exists.
- Press the Hold key twice to get to the temporary display.
- A *temporary* ends when the RSVP price changes to a rate programmed to switch on the Water or Appliance.

Recovery From Setback

Recovery is the time when the thermostat operates the heating or cooling equipment to return the house from the energy savings to the temperature you prefer when you are present and awake.

This thermostat uses a recovery process that turns your heating/cooling equipment on or off at the time you program the temperature to change. For example, if you set the thermostat to heat to 72°F at 6:00 AM, the heating equipment comes on at 6:00 AM and begins warming the house to 72°F. If you want the temperature in the house to be 72°F at 6:00 AM, you must set the thermostat to turn on earlier; for example, 5:30. (The amount of time required to warm or cool your house to the temperature you want depends on many factors such as the size of your heating/cooling equipment and the outdoor temperature.)

NOTE: If the thermostat is for a heat pump system, the thermostat uses a method of recovery that helps reduce the use of auxiliary heat.

Programming Your Thermostat

IMPORTANT

Press and release the Present Setting key to exit programming and return to the standard display.

NOTES:

- Energy prices supplied by Gulf Power may influence the times you choose to schedule periods for maximum energy efficiency.
- Each period can occur at any programmed time; for example, you can set morning at 9 PM. When you program the thermostat, be careful to use the correct time to avoid confusion.

MORN is the time you get up. Generally, you want the house at a comfortable temperature when you wake up. Set the MORN time earlier than your alarm clock so your home has time to reach the desired temperature.

DAY is the time you leave for work or school. Generally, once you leave your home, you want the temperature higher or lower (depending on the season) so that you can save energy while you are away.

EVE is the time you return from work or school. Again, you want your home at a comfortable temperature when you return and go about the normal activities of your evening. Set the EVE time earlier

than the time you arrive so your home has time to reach the desired temperature before you get there.

NIGHT is the time you usually go to sleep. While you are sleeping, you can save energy by setting the thermostat to control the temperature higher or lower (depending on the season).

If you choose not to program the thermostat, it controls the temperature using the following defaults:

- The cooling temperature remains set to a constant 78°F.
- At 6:00 AM every day, the thermostat sets the heating temperature to 68°F.
- At 10:00 PM every night, the thermostat reduces the heating temperature to 60°F

You do not need to enter a time and temperature program for every period if your schedule does not require it; for example, if your home is occupied during the day on weekdays, you can program only the MORN and NIGHT times.

NOTE: You cannot set temperatures higher than 88°F or lower than 45°F.

Price Response

You can also program the thermostat based on the current price of electricity. Use Tables 7 and 8 to plan the Price Response program.

Price Response programming allows the thermostat to respond to changes in the RSVP prices. Gulf Power tells the thermostat what the current RSVP price is for electricity. These prices are: Low (least expensive), Medium,

High, and Critical (most expensive). As the cost of energy increases, the thermostat uses your pre-programmed choices to reduce usage by temporarily changing the setpoint; that is, it changes the temperature setting—increasing it for cooling, decreasing it for heating—or turns off the water heater and/or appliance.

NOTE: You can enter the number of degrees you want the thermostat to change the temperature (offsets) for each price except Low. The Low price always uses whatever schedule programming exists and it is the basis for the offsets. The one exception is the water heater, which is always enabled during the low price.



CAUTION

Equipment Damage Hazard.

Use of sharp fingernails or pencil points can damage the keypad beyond repair.

Use the ball of your finger or a soft pencil eraser when pressing the keys.

IMPORTANT

When programming for the appliance, make certain that you consider potential safety issues; for example: with a pool pump during winter freezing weather, you will have to operate the pool pump as you have always done to prevent pump and pipe freezing.

NOTE: Before programming the thermostat, remove the clear protective plastic display overlay.

Entering Schedule Programming

Refer to your Personal Programming Charts and proceed as follows:

IMPORTANT

The thermostat registers all programming inputs immediately and maintains them until manually changed. Low batteries or power outages do not delete thermostat programming.

NOTE: When setting a program time or temperature, the instructions direct you to “Press and hold until the display shows the desired time (or temperature).” This changes the setting quickly in the selected direction. Use this method when the change is large (for example, two hours, or ten degrees). Once the setting is close, press and release the key to move the setting one step at a time.

Inputting Basic Program

The most efficient way to program the thermostat is to first input a basic program for the entire week. Then, you can make changes to specific days to fit your needs.

IMPORTANT

Because this procedure can affect up to seven days of programming, be careful when making changes with multiple days selected.

NOTES:

- If you delete *all* programming with the CLEAR key, the thermostat uses the default program.
- PGM is an indication that you are in programming mode.

Step 1: Setting Basic Cooling Times and Temperatures.

First program the MORN time and temperature, if desired, for the entire week.

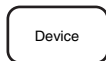

Press and release until the display shows PGM COOL.



M15- 03

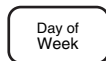

Press and release until the display shows MON TUE WED THU FRI SAT SUN.



M15- 03

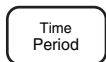

Press and release until the display shows MORN.



M15403



Ahead



Back



Warmer

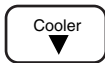

Cooler

Press and hold until the display shows the desired time.

Press and hold until the display shows the desired temperature.



M15404



M15405

Program the DAY time and temperature, if desired, for the entire week.

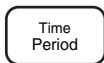

Press and release until the display shows DAY.

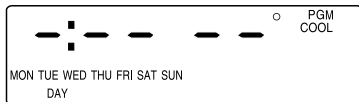

M15406



Press and hold until the display shows the desired time.



M15407

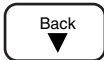

Press and hold until the display shows the desired temperature.

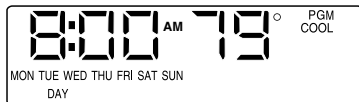

M15408

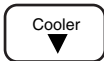

Program the EVE time and temperature, if desired, for the entire week.

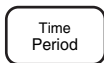

Press and release until the display shows EVE.

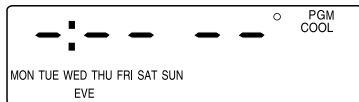

M15409



Press and hold until the display shows the desired time.



M15410



Press and hold until the display shows the desired temperature.

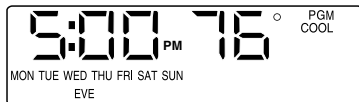

M15411

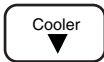

Program the NIGHT time and temperature, if desired, for the entire week.

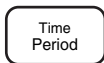

Press and release until the display shows NIGHT.

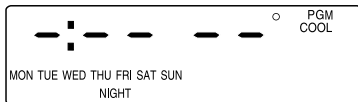

M15412



Press and hold until the display shows the desired time.

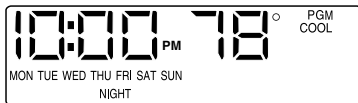

M15413

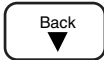

Press and hold until the display shows the desired temperature.

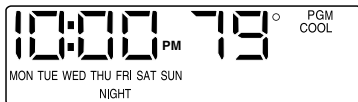

M15414

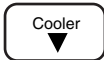

Step 2: Setting Basic Heating Times and Temperatures.

First program the MORN time and temperature, if desired, for the entire week.

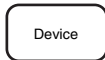

Press and release until the display shows PGM HEAT.

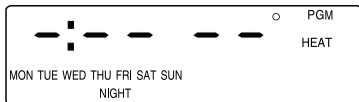

M15415

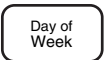

Press and release until the display shows MON TUE WED THU FRI SAT SUN.

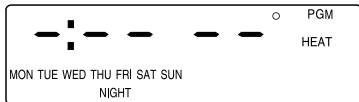

M15415

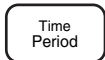

Press and release until the display shows MORN.



M15416



Ahead



Back

Press and hold until the display shows the desired time.



Warmer

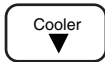

Cooler

Press and hold until the display shows the desired temperature.



M15417



M15418

Program the DAY time and temperature, if desired, for the entire week.

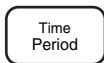

Press and release until the display shows DAY.

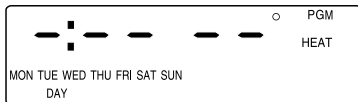

M15419



Press and hold until the display shows the desired time.



M15420



Press and hold until the display shows the desired temperature.



M15421

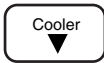

Program the EVE time and temperature, if desired, for the entire week.

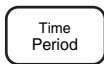

Press and release until the display shows EVE.

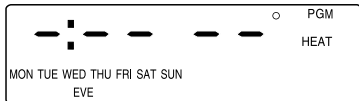

M15422



Press and hold until the display shows the desired time.



M15423

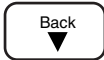

Press and hold until the display shows the desired temperature.

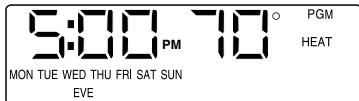

M15424

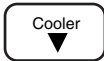

Program the NIGHT time and temperature, if desired, for the entire week.

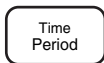

Press and release until the display shows NIGHT.



M15425



Press and hold until the display shows the desired time.



M15425



Press and hold until the display shows the desired temperature.

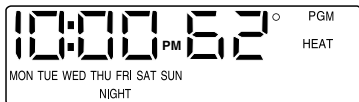

M15426

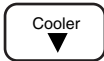

Step 3: Setting Basic Water Times and On/Off Settings.

First program the MORN time and on/off setting, if desired, for the entire week.

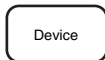

Press and release until the display shows PGM WATER.

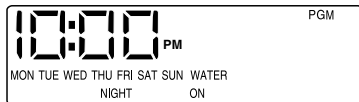

M15427

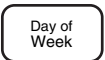

Press and release until the display shows MON TUE WED THU FRI SAT SUN.

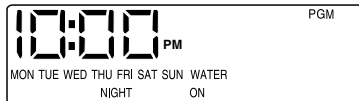

M15427

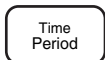

Press and release until the display shows MORN.

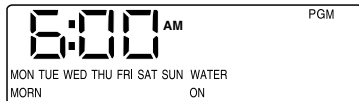

M15428

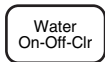

Press and hold until the display shows the desired time.

Press and release until the display shows the desired on/off setting.

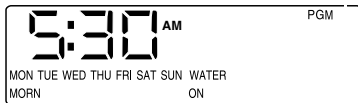

M15-29

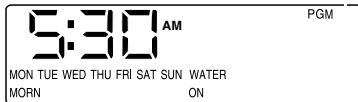

M15429

Program the DAY time and on/off setting, if desired, for the entire week.

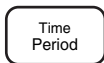

Press and release until the display shows DAY.

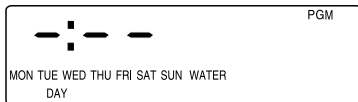

M15430



Press and hold until the display shows the desired time.

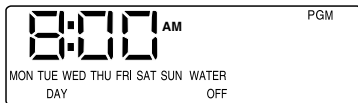

M15431



Press and hold until the display shows the desired on/off setting.

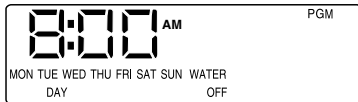
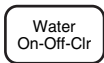

M15431

Program the EVE time and on/off setting, if desired, for the entire week.

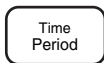

Press and release until the display shows EVE.

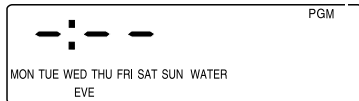

M15-32



Press and hold until the display shows the desired time.

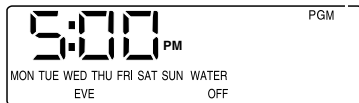

M15-33

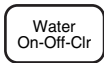

Press and hold until the display shows the desired on/off setting.

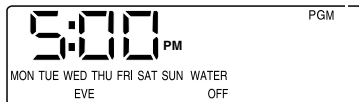

M15433

Program the NIGHT time and on/off setting, if desired, for the entire week.

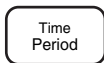

Press and release until the display shows NIGHT.

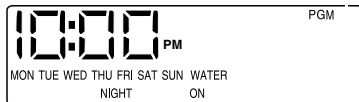

M15-34



Press and hold until the display shows the desired time.

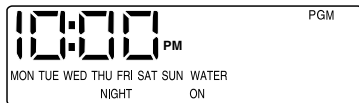

M15434

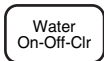
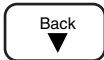

Press and hold until the display shows the desired on/off setting.

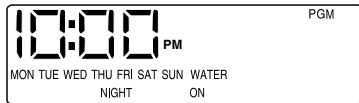

M15434

Step 4: Setting Basic Appliance Times and On/Off Settings.

First program the MORN time and on/off setting, if desired, for the entire week.

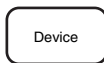

Press and release until the display shows PGM APPL.

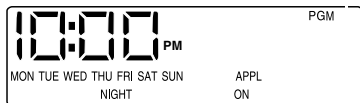

M15-43



Press and release until the display shows MON TUE WED THU FRI SAT SUN.

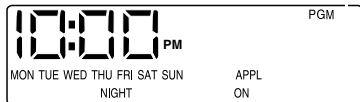

M15-43

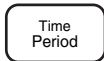

Press and release until the display shows MORN.



M15436



Press and hold until the display shows the desired time.

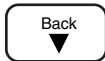

Press and hold until the display shows the desired on/off setting.



M15-37



M15437

Program the DAY time and on/off setting, if desired, for the entire week.

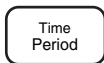

Press and release until the display shows DAY.

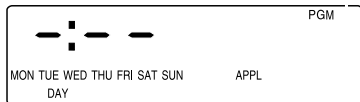

M15-38



Press and hold until the display shows the desired time.



M15-39



Press and hold until the display shows the desired on/off setting.



M15439

Program the EVE time and on/off setting, if desired, for the entire week.

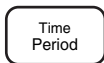

Press and release until the display shows EVE.

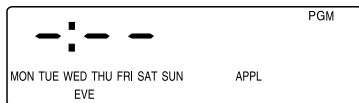

M15440



Press and hold until the display shows the desired time.

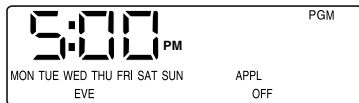

M15441

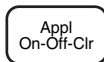
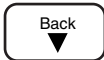

Press and hold until the display shows the desired on/off setting.

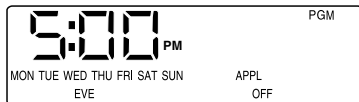

M15441

Program the NIGHT time and on/off setting, if desired, for the entire week.

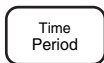

Press and release until the display shows NIGHT.

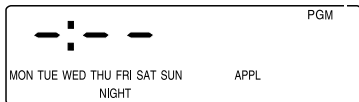

M115-42



Press and hold until the display shows the desired time.

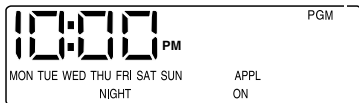

M115-43

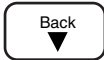

Press and hold until the display shows the desired on/off setting.

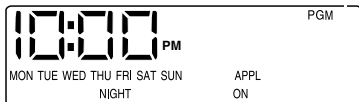

M115443

Changing Parts of the Program

After you input the basic program for the entire week, make changes to specific days to tailor the program to fit your needs.

IMPORTANT

Because this procedure can affect up to seven days of programming, be careful when making changes with multiple days selected.

Step 5: Changing Individual Cooling Times and Temperatures.

The following example illustrates modifying the Sunday Morning Cooling program.

First, select COOL, and the desired day and period for the change.

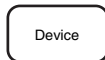

Press and release until the display shows PGM COOL.



Press and release until the display shows the desired day(s).

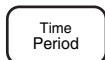
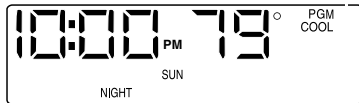

Press and release until the display shows the desired period.



Adjust the time that the period begins.



Press and hold until the display shows the desired time.



Press and hold until the display shows the desired temperature.

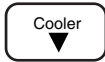

OR

Delete the programming from the period for the days shown on the display.

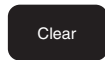

Press and release.

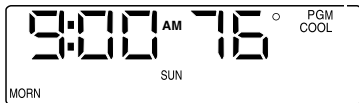

M15-46



M15-48

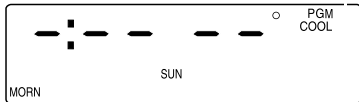

M15-47

Step 6: Changing Individual Heating Times and Temperatures.

The following example illustrates modifying the Saturday Day Heating program.

First, select HEAT, and the desired day and period for the change.

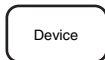

Press and release until the display shows PGM HEAT.

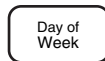

Press and release until the display shows the desired day(s).

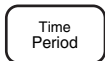

Press and release until the display shows the desired period.



Adjust the time that the period begins.



Press and hold until the display shows the desired time.

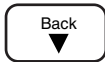

M15-51



Press and hold until the display shows the desired temperature.

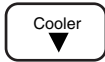

M15-52

OR

Delete the programming from the period for the days shown on the display.



Press and release.

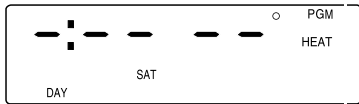

M15-53

Step 7: Changing Individual Water Times and On/Off Settings.

The following example illustrates modifying the Saturday Evening Water program.

First, select WATER, and the desired day and period for the change.

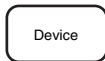

Press and release until the display shows PGM WATER.

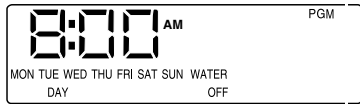

M15-31



Press and release until the display shows the desired day(s).

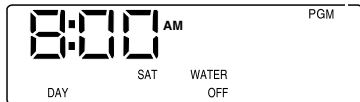

M15-54

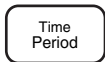

Press and release until the display shows the desired period.

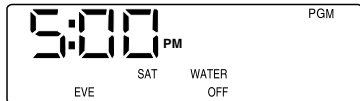

M15455

Adjust the time that the period begins.



Press and hold until the display shows the desired time.

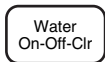

Press and release until the display shows the desired on/off setting.

OR

Delete the programming from the period for the days shown on the display.

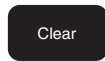

Press and release. The WATER indication shows neither on nor off.

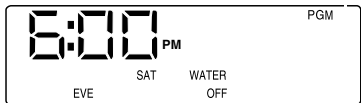

M15-56

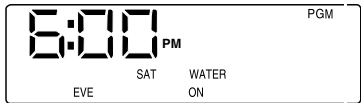

M15-58

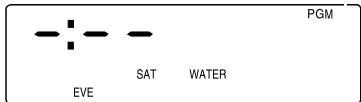

M15-57

Step 8: Changing Individual Appliance Times and On/Off Settings.

The following example illustrates modifying the Saturday Day Appliance program.

First, select APPL, and the desired day and period for the change.

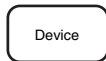

Press and release until the display shows PGM APPL.



M15-36



Press and release until the display shows the desired day(s).

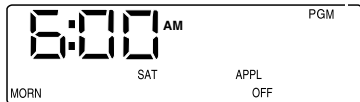

M15-59

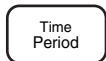

Press and release until the display shows the desired period.

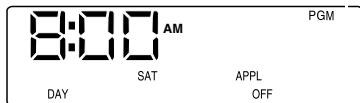

M15460

Adjust the time that the period begins:



Press and hold until the display shows the desired time.



Press and release until the display shows the desired on/off setting.

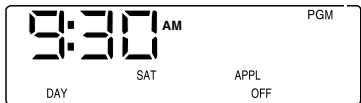

M15-81

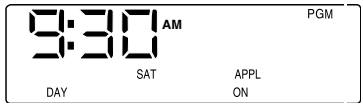

M15-83

OR

Delete the programming from the period for the days shown on the display:



Press and release. APPL indication shows neither on nor off.

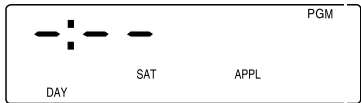

M15-82

NOTE: If you set the period start times so the next period begins before the current period then the Heat/Cool system uses periods out of expected order; for example, NIGHT can occur before EVE.

Programming Price Response Overview

Price response allows the thermostat to respond to changes in the RSVP prices. Gulf Power tells the thermostat what the current RSVP price is for electricity. These prices are: Low (least expensive), Medium, High, and Critical (most expensive). As the cost of energy increases, the thermostat reduces usage by temporarily changing the setpoint; that is, it changes the temperature setting—increasing it for cooling, decreasing it for heating—or turns off the water heater and/or appliance. If you do not enter any price offsets, the thermostat uses the default settings (see Table 2).

Table 2. Price Response Program Defaults.

Price Rate	Setpoint Offset (°F or °C)		Hot Water	Appl
	Heat	Cool		
Low¹	0	0	on	on
Medium	-1	+1	on	on
High	-2	+2	on	on
Critical	-5	+5	off	off

¹The Low Price Response settings are fixed and cannot be changed.

Heat offsets are always negative (less heat to save energy). Cool offsets are always positive (less cooling to save energy). Hot Water and Appliance settings are simply *on* or *off*.

The offset entered is the number of degrees you are willing to allow the heating or cooling

temperature to change from what you programmed for normal operation to save money at each price. Think of the Price Response programming as what you are willing to give up to save money when RSVP prices increase.

With an appliance, the APPL indicator lights with either an ON or an OFF indication. With APPL set to OFF at a particular price, when the price reaches that level, the appliance load turns off, ignoring the program schedule. The water indicator works identically to the appliance indicator with one exception: when the RSVP price is low the water indicator is *always* on.

NOTE: Price Response programming does not affect temperature, water, or appliance holds.

For example, if you want your home heated to 72° during low rate, but are willing to allow the temperature down as low as 70° during high rate, your heat offset for rate *H* (high) is -2 (72° - 2° = 70°). If you do not enter an offset, the offset remains as shown in Table 2.

If you program an incorrect offset, press and release the Clear key. This changes the offset on the display to zero. The Clear key works for all programmable rates.

Entering Price Response Programming

Price Response programming is very similar to the other programming. One primary difference is that you can program the temperature offsets and water/appliance setting changes from the same display. The same water and appliance setting changes apply for both heating and cooling. Therefore, they need only be set once. Program them from either the heating or the cooling offset display. The following programming instructions—both heating and cooling—detail this process.

Step 1: Setting Price Offsets for Cooling.

First, program the Medium offset.

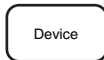

Press and release until the display shows PGM COOL.

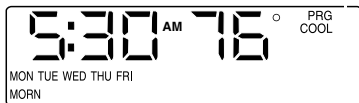

M15-85

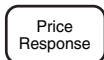

Press and release the key to show OF (indicating temperature offset).

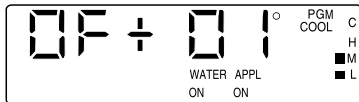

M15487

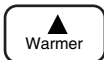

Press and release until the display shows the desired (positive) temperature offset.

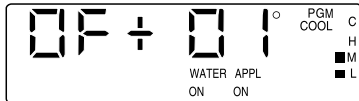
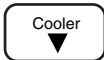

M15487

Next, program
the High offset.

Water
On-Off-Clr

Press and release until the display shows the desired Water on/off setting for the Medium offset.

Appl
On-Off-Clr

Press and release until the display shows the desired Appliance on/off setting for the Medium offset.

Price
Response

Press and release the key to show OF (indicating temperature offset).

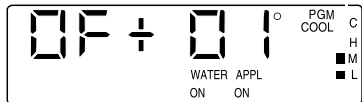

M15-87

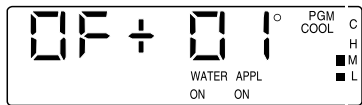

M15-87

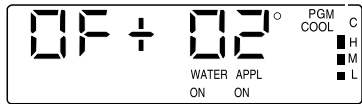

M15488

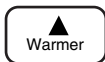

Warmer

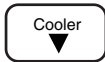

Cooler

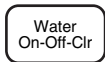

Water
On-Off-Clr



Appl
On-Off-Clr

Press and release until the display shows the desired (positive) temperature offset.

Press and release until the display shows the desired Water on/off setting for the High offset.

Press and release until the display shows the desired Appliance on/off setting for the High offset.

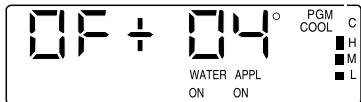

M15-89

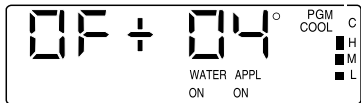

M15-89

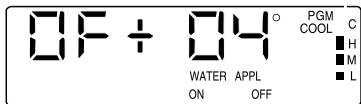

M15490

Then, program the Critical offset.

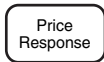

Press and release the key to show OF (indicating temperature offset).

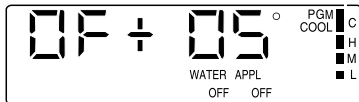

M15-91



Press and release until the display shows the desired (positive) temperature offset.

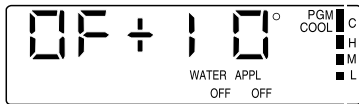

M15-93

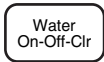
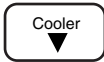

Press and release until the display shows the desired Water on/off setting for the Critical offset.

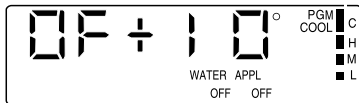

M15-93



Press and release until the display shows the desired Appliance on/off setting for the Critical offset.

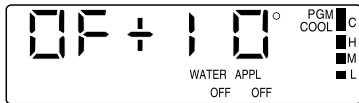

M15493

Step 2: Setting Price Offsets for Heating.

First, program the Medium offset.

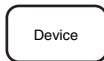

Press and release until the display shows PGM HEAT.



M15-94

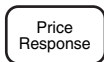

Press and release until the display shows OF (indicating temperature offset).

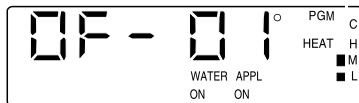

M15-97



Press and release until the display shows the desired (negative) temperature offset.

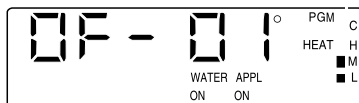
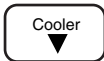

M15497

Next, program the High offset.

Water
On-Off-Clr

Press and release until the display shows the desired Water on/off setting for the Medium offset.

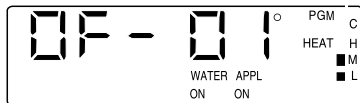

M15-97

Appl
On-Off-Clr

Press and release until the display shows the desired Appliance on/off setting for the Medium offset.

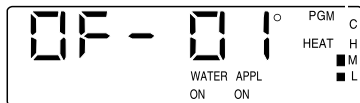

M15-97

Price
Response

Press and release the key to show OF (indicating temperature offset).

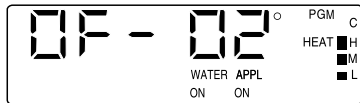

M15498

▲
Warmer

▼
Cooler

Press and release until the display shows the desired (negative) temperature offset.

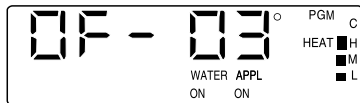

M15499

Then, program the Critical offset.

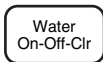

Press and release until the display shows the desired Water on/off setting for the High offset.

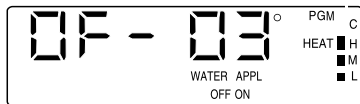

M15i:01



Press and release until the display shows the desired Appliance on/off setting for the High offset.

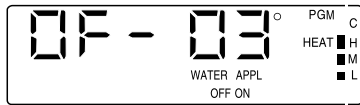

M15i:01

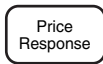

Press and release the key to show OF (indicating temperature offset).

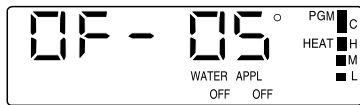

M15502

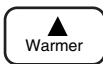

Press and release until the display shows the desired (negative) temperature offset.

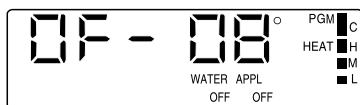

M15503

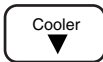

After you have finished programming offset values, return to standard display.

Water
On-Off-Clr

Press and release until the display shows the desired Water on/off setting for the Critical offset.

Appl
On-Off-Clr

Press and release until the display shows the desired Appliance on/off setting for the Critical offset.

Present
Setting

Press and release to return to the standard display.

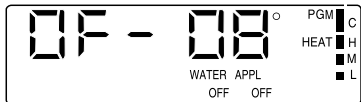

M15:03

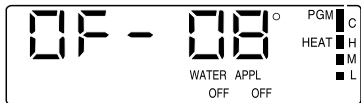

M15:03

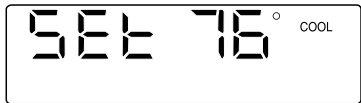

M15484

Controlling Heat/Cool System

With a conventional heating/cooling system, you can set the system to: HEAT, COOL or OFF. With a heat pump system, you can set the system to: COOL, HEAT, EM HEAT, or OFF.

Changing the System Setting

Manually change the system setting.

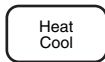

Press and release until the display shows the desired system status.



M15504

HEAT: The thermostat controls your heating system according to the schedule you programmed.

Heat pump models display AUX and the indicator light flashes denoting auxiliary heat element operation, see Table 1.

EM HEAT: The emergency heater element of the heat pump is enabled.

COOL: The thermostat controls your cooling system according to the schedule you programmed.

No status displayed: Both the heating and cooling systems are off.

Controlling Fan

There are two fan settings: AUTO and ON.

To select the fan setting, press the *Fan* key. Each time you press the key, the fan status changes to the next setting.

With FAN displayed, the fan is on continuously. Use this setting for improved air circulation or during special occasions of short duration.

With nothing displayed, the fan is in AUTO mode (it comes on with the heating or cooling equipment, as needed). AUTO is the typical setting. If you have a two-speed fan, it usually runs on high with cooling and on low with heating.

Troubleshooting

IF...	THEN...
Display does not come on.	<ul style="list-style-type: none">• There is no power being supplied to the thermostat. Check fuse or circuit breaker.• Check the furnace air filter. A dirty filter will choke the airflow causing safety shutdown; replace or clean, if necessary.
Temperature display does not go lower than 45°F or higher than 88°F during programming.	<ul style="list-style-type: none">• You have reached the thermostat setting limit. The setting range is 45°F to 88°F.
Temperature change occurs at the wrong time.	<ul style="list-style-type: none">• Check programming for the period in question. Be sure the time—including AM/PM indication—is correct. Reprogram if necessary.• Keep in mind that it takes time for the system to recover. Refer to the Recovery from Setback section for details.

(continued)

Troubleshooting Guide (continued)

IF...	THEN...
Heating unit does not come on.	<ul style="list-style-type: none">• Check that the thermostat is set to heat. If it is not, press the <i>Heat/Cool</i> key until the display indicates HEAT.• If the temperature setting is higher than current temperature, and display indicates HEAT, contact Gulf Power.• Heat pump thermostats have a built-in five minute time delay for heating. After changing the setting, the thermostat delays before starting the heating to prevent equipment damage.
Cooling does not come on.	<ul style="list-style-type: none">• Check that the thermostat is set to cool. If it is not, press the <i>Heat/Cool</i> key until the display indicates COOL.• Check the fuse or circuit breaker and replace or reset, if necessary.• The thermostat has a built-in five minute time delay for cooling. After changing the setting, the thermostat delays before starting the cooling to prevent equipment damage.

IF...	THEN...
<p>Cooling does not come on (continued).</p>	<ul style="list-style-type: none"> • If temperature setting is lower than current temperature and the display indicates COOL, set the system control OFF for ten minutes. After ten minutes, return the system control to cool. If the cooling comes on, the compressor may have reached a safety limit and shut down. If the air conditioner does not come on after ten minutes and the display shows COOL, contact Gulf Power.
<p>The house is too warm or too cool.</p>	<ul style="list-style-type: none"> • Press the <i>Present Setting</i> key to check the temperature setting. • If desired, change the temperature setting (see Holds section). • The RSVP Rate may be adjusting the setting beyond what you desire. Check your offset temperatures; you may need to change them to provide a more comfortable temperature.
<p>System ON indicated but no heat is coming from the vents.</p>	<ul style="list-style-type: none"> • Allow time for the furnace or heat pump to heat up and the fan to come on before checking for heat at the vent.

(continued)

Troubleshooting Guide (continued)

IF...	THEN...
Thermostat current setting does not match the display temperature.	<ul style="list-style-type: none">• Be aware that it is normal for the current setting and display temperature to differ on occasion.• During recovery from setback or setup, setting and display temperatures may differ during the recovery period.
Incorrect room temperature is showing on thermostat display.	<ul style="list-style-type: none">• The thermostat is factory-calibrated and cannot be adjusted.
Thermostat is flashing CALL followed by a phone number.	<ul style="list-style-type: none">• Your thermostat has lost communication with Gulf Power. Call the number displayed on the thermostat or the number on the thermostat label for information.
Hot water and appliance devices are not functioning per schedule.	<ul style="list-style-type: none">• Verify programming for loads and Time-of-Use rate.• Communications are not properly functioning. Contact Gulf Power.
Temperature displayed as “- -”.	<ul style="list-style-type: none">• Temperature sensor has failed.• Temperature is out of thermostat operating range.

IF...	THEN...
Clock gives erroneous reading.	<ul style="list-style-type: none"> • Check to see if display shows low battery, if so replace batteries. • Gulf Power sets the clock and it cannot be adjusted by the customer. If necessary, contact Gulf Power.
Clock occasionally changes more than one minute at a time.	<ul style="list-style-type: none"> • Gulf Power periodically resets the clock to the correct time. This can change the time more than one minute (see Replacing the Batteries section).
Thermostat displays: “bUSY”.	<ul style="list-style-type: none"> • If condition persists for more than one minute, the thermostat cannot establish the communication link; contact Gulf Power.

Personal Programming Charts

Table 3. Cooling Schedule (For Summer Use).

Cool	Morning		Day		Evening		Night	
	Time	Setting	Time	Setting	Time	Setting	Time	Setting
Mon								
Tue								
Wed								
Thur								
Fri								
Sat								
Sun								

Table 4. Heating Schedule (For Winter Use).

Heat	Morning		Day		Evening		Night	
	Time	Setting	Time	Setting	Time	Setting	Time	Setting
Mon								
Tue								
Wed								
Thur								
Fri								
Sat								
Sun								

Table 5. Water Schedule (For Hot Water Control).

Water	Morning		Day		Evening		Night	
	Time	On/Off	Time	On/Off	Time	On/Off	Time	On/Off
Mon								
Tue								
Wed								
Thur								
Fri								
Sat								
Sun								

NOTE: The *On* setting refers to enabling the operating mode; you cannot program a water heater “on”.

Table 6. Appliance Schedule (For One Appliance Control).

Appl	Morning		Day		Evening		Night	
	Time	On/Off	Time	On/Off	Time	On/Off	Time	On/Off
Mon								
Tue								
Wed								
Thur								
Fri								
Sat								
Sun								

Table 7. Offset Values for RSVP Rate.

Offsets (+) for Cooling (setpoint increase)				Offsets (-) for Heating (setpoint decrease)			
Price L	Price M	Price H	Price C	Price L	Price M	Price H	Price C
N/A				N/A			

Table 8. Water and Appliance Offsets for RSVP Rate.

On/Off setting for Water				On/Off setting for Appliance			
Price L	Price M	Price H	Price C	Price L	Price M	Price H	Price C
N/A				N/A			

Customer Assistance

For all questions concerning this thermostat, please read and follow the instructions. If you need additional assistance, call the Gulf Power Customer Assistance number printed on the thermostat label.

Before you call, please have the following information available:

- Thermostat model number and date code located under the battery cover (example: T7516A1000 and 9743).
- Type of heating/cooling system (hot water, warm air, oil, gas, heat pump, etc.).

Warranty

Honeywell warrants this product, excluding battery, to be free from defects in the workmanship or materials, under normal use and service, for a period of one (1) year from the date of purchase by the consumer. If, at any time during the warranty period, the product is defective or malfunctions, Honeywell shall repair or replace it (at Honeywell's option) within a reasonable period of time.

If the product is defective,

- (i) return it, with a bill of sale or other dated proof of purchase, to the retailer from which you purchased it, or
- (ii) package it carefully, along with proof of purchase (including date of purchase) and a short description of the malfunction, and mail it, postage prepaid, to the following address:
Honeywell Return Goods
1885 Douglas Drive
Golden Valley, MN 55422

This warranty does not cover removal or reinstallation costs. This warranty shall not apply if it is shown by Honeywell that the defect or malfunction was caused by damage which occurred while the product was in the possession of a consumer.

Honeywell's sole responsibility shall be to repair or replace the product within the terms stated above. HONEYWELL SHALL NOT BE LIABLE FOR ANY LOSS OR DAMAGE OF ANY KIND, INCLUDING ANY INCIDENTAL OR CONSEQUENTIAL DAMAGES RESULTING, DIRECTLY OR INDIRECTLY, FROM ANY BREACH OF ANY WARRANTY, EXPRESS OR IMPLIED, OR ANY OTHER FAILURE OF THIS PRODUCT. Some states do not allow the exclusion or limitation of incidental or consequential damages, so this limitation may not apply to you.

THIS WARRANTY IS THE ONLY EXPRESS WARRANTY HONEYWELL MAKES ON THIS PRODUCT. THE DURATION OF ANY IMPLIED WARRANTIES, INCLUDING THE WARRANTIES OF MERCHANTABILITY AND FITNESS FOR A PARTICULAR PURPOSE, IS HEREBY LIMITED TO THE ONE YEAR DURATION OF THIS WARRANTY. Some states do not allow limitations on how long an implied warranty lasts, so the above limitation may not apply to you.

This warranty gives you specific legal rights, and you may have other rights which vary from state to state.

If you have any questions concerning this warranty, please write to Home and Building Control Customer Relations, Honeywell Inc., 1985 Douglas Drive North, Minneapolis, Minnesota 55422. In Canada, Honeywell Limited/Honeywell Limitée, Dynamic Drive, Scarborough, Ontario, M1V 4Z9.

Honeywell

Home and Building Control

Honeywell Inc.
Honeywell Plaza
P.O. Box 524
Minneapolis, MN 55408-0524

Home and Building Control

Honeywell Limited-Honeywell Limitée
155 Gordon Baker Road
North York, Ontario
M2H 3N7

Copyright © 1998 Honeywell Inc.
All Rights Reserved ® U.S. Registered Trademark
69-1154—1 Rev. 7-98 B.B.



Printed in U.S.A. on recycled
paper containing at least 10%
post-consumer paper fibers.

www.honeywell.com/yourhome