

## MagicStat® CT3300 Programmable Thermostat

### Installation and Programming Instructions



**Welcome** to the world of comfort and energy savings with your new Honeywell MagicStat® Programmable Thermostat. Your new thermostat will automatically control the temperature in your home, keeping you comfortable while saving energy.

If you have any questions about using this thermostat, visit our home expert Web site at [www.honeywell.com/yourhome](http://www.honeywell.com/yourhome) or call Honeywell Customer Relations at 1-800-468-1502.

Weekday/Weekend (5-day/2-day)  
Programmable Heat and/or Cool  
Low Voltage (20 to 30 Vac)  
Thermostat and Mounting Plate  
Model CT3300

### Table of Contents

---

Installation	2
Programming	11
Operation	17
Change the clock for Daylight/ Standard Time	17
Set the Fan and System switches	17
Replace the batteries	18
Override the program settings	19
Frequently asked questions	22
Limited 1-Year Warranty	24



Fig. 1

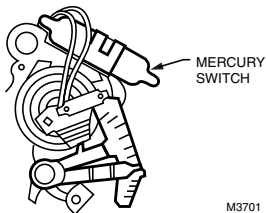

## Recycling thermostat

If you are removing an old thermostat that contains mercury in a sealed tube (Fig. 1), **do not** place the old thermostat in the trash. Contact your local waste management authority for instructions regarding recycling and the proper disposal of the old thermostat.

## Installation

### Verify that you have the right thermostat

Make sure that the CT3300 is the right thermostat for your heating/cooling system. Read the compatibility chart below to determine which system you have. If your system is not compatible with the CT3300, the table recommends an alternate Honeywell model. If you are unsure what type of thermostat is right for your system, visit us on the Web at [www.honeywell.com/yourhome](http://www.honeywell.com/yourhome) or call Honeywell Customer Relations at 1-800-468-1502.

Heating/cooling system	Compatible with CT3300?	Alternate model
<b>Conventional</b> Single stage systems that include warm air furnaces and hot water.	Yes	
<b>Electric Baseboard</b> Electric powered heating strips located just above the floor, usually 120 to 240 volts.	No	CT1950 for 240 volts
<b>Steam</b> A steam boiler with radiator heat.	No	CT3600
<b>Heat Pump</b> Heating and cooling are produced from the same outdoor unit (compressor) with no auxiliary or backup heat.	No	CT3600
<b>Multistage Heat Pump</b> Heating and cooling are produced from the same outdoor unit (compressor) with auxiliary or backup heat.	No	CT3611
<b>Multistage Conventional</b> A heating or cooling system with more than one stage.	No	See your contractor

## Step 1. Prepare for installation

- a. Carefully unpack your new thermostat. Save your receipt and make sure you have the following parts:
  - Thermostat and mounting plate
  - Labels
  - Screws and anchors
  - Installation and Programming Instructions
- b. Gather the needed tools and supplies listed below.

Required tools and supplies	Optional tools
<ul style="list-style-type: none"><li>• Two AA alkaline batteries. Honeywell recommends Energizer® batteries.</li><li>• Screwdriver</li><li>• Hand or power drill with 3/16-inch or 7/32-inch drill bit</li><li>• Pencil</li></ul>	<ul style="list-style-type: none"><li>• Wire cutter/stripper or sharp knife</li><li>• Level</li><li>• Electrical tape</li></ul>

- c. Make sure that your heating and cooling systems are working properly. If there is a problem with either system, call a heating/air conditioning contractor—the problem may persist after you install the new thermostat.

**IMPORTANT:** To avoid damaging the compressor in the air conditioner, do not operate the cooling system when the temperature outdoors is below 50°F (10°C).

## Step 2. Remove the old thermostat

Fig. 2

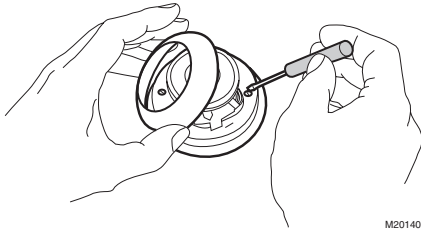

M20140

Fig. 3

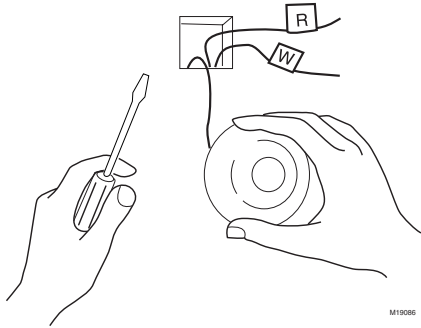

M19086

Fig. 4

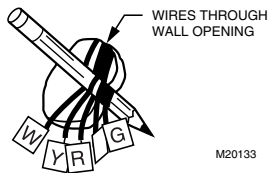

M20133

- Turn off power to the heating/cooling system, either at the furnace or at the fuse/circuit breaker panel.
- Remove the cover of your old thermostat (Fig. 2).
- Unscrew and remove the old thermostat's mounting plate from the wall, but **do not disconnect the wires**.
- Inspect the old thermostat wiring. **If the wiring meets any of the following conditions, see the special wiring instructions on page 9.**
  - The old thermostat is a clock thermostat with wires attached to the C or C1 terminals.
  - The old thermostat has 6 or more wires, excluding wires attached to C or C1 terminals.
  - The old thermostat has 3 wires.
  - There are 5 wires **connected** to the old thermostat.
  - There are extra wires that are **not** connected to the old thermostat.
- Using the enclosed labels, mark the wires with the letter of the terminal that it is attached to on the **old thermostat** (Fig. 3). Do not label the wires by color.

If the labels do not match the letters on the old thermostat terminals, see the wiring cross reference table on page 10.
- Disconnect the wires from the old thermostat and wrap the wires around a pencil to keep them from falling back into the wall.

**Note:** Remember, if your old thermostat contains mercury, you must recycle it. See page 2 for more recycling information.

### ✓ Check your progress

Your wall should now look like Fig. 4.

### Step 3. Install the mounting plate

Fig. 5

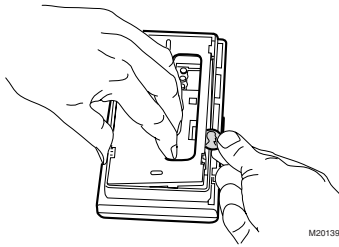

- a. Separate the mounting plate from the thermostat using a coin, as shown in Fig 5.
- b. Position the mounting plate on the wall. Be sure the mounting plate sits flush against the wall and none of the wires are trapped behind it.
- c. Level the mounting plate and use a pencil to mark the center of the mounting plate's screw holes.
- d. Remove the mounting plate and drill holes at the locations you marked.
  - For drywall, drill two 3/16 inch holes.
  - For plaster or wood, drill two 7/32 inch holes.
- e. If installing in drywall, gently tap the anchors that were provided into the drilled holes until they are flush with the wall.
- f. Reposition the mounting plate over the holes, pull the wires through the wiring opening, and loosely insert the mounting screws into each of the drilled holes or anchors (Fig. 6).
- g. Make sure the mounting plate is level and tighten the mounting screws.

Fig. 6

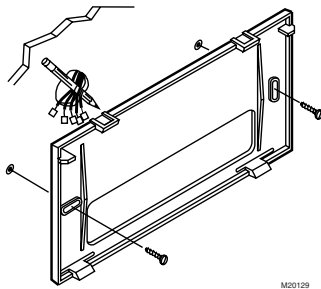
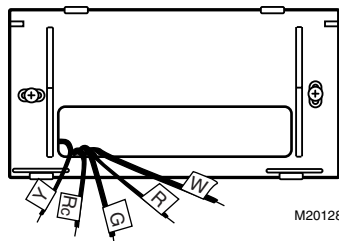

Fig. 7



#### ✓ Check your progress

The mounting plate is now mounted on the wall and should look like Fig. 7.

## Step 4. Set the thermostat for your type of heating system

Fig. 8

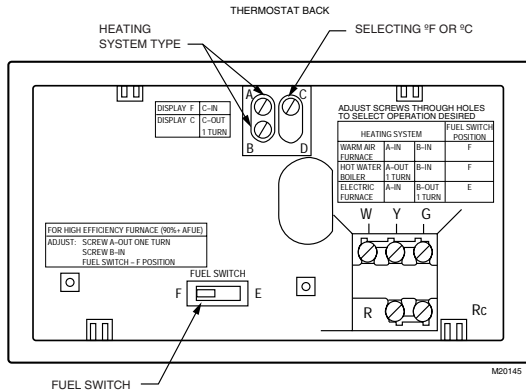

**IMPORTANT:** Setting your thermostat correctly for your type of heating system allows it to maintain accurate temperature control, minimize swings in the temperature of the room, and efficiently run the fan.

- Use the **FUEL SWITCH** on the back of the thermostat to set your new thermostat for the type of fuel that your heating system uses: F—gas or oil, or E—electricity.
 

**Note:** This setting enables proper fan operation.
- Use the A and B screws on the back of the thermostat to set your new thermostat for your type of heating system. See the heating system table on the next page to find the correct settings.
 

**Note:** These screws are factory-set for a warm air, gas, or oil heating system.
- The thermostat is set to display the temperature in degrees Fahrenheit (°F). If you want to display the temperature in degrees Celsius (°C), adjust screw C out one turn.
- You can install the batteries and program your thermostat now, or you can wait until the thermostat is mounted on the wall. To install the batteries, see the instructions on page 8. To program the thermostat, see the instructions that begin on page 12.

## Heating system table

**Note:** Setting the screw “out one turn” means turning the screw 360° counter-clockwise, or one complete turn.

Type of system	Screws A and B	Fuel switch
Warm air, gas, or oil heating system with an efficiency rating under 90%. (The furnace efficiency rating should be on the furnace.)	Use factory setting A—leave in B—leave in	F
High-efficiency furnace such as a 90% or greater AFUE (Average Fuel Utilization Efficiency) unit	A—out one turn B—leave in	F
Hot water boiler	A—out one turn B—leave in	F
Electric furnace	A—leave in B—out one turn	E

## Step 5. Wire the thermostat terminals

Fig. 9

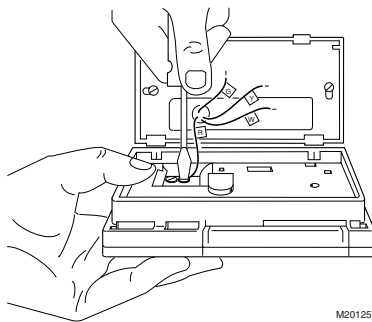

- Hold the thermostat as shown in Fig. 9.
- Using the labels on the wires, match the letter of your old thermostat wire with the corresponding terminal on the back of your new thermostat.

**Note:** If the letters on the old thermostat terminals do not match the letters on the new thermostat terminals, you might not need to connect all of the old wires to the new thermostat. See the wiring cross reference table on page 10 for details.

- Loosen the terminal screws and slip each wire beneath its matching terminal (Fig 10).
- Securely tighten the terminals.

Fig. 10

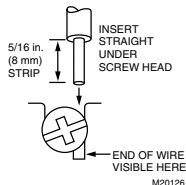

## Step 6. Mount the thermostat

Fig. 11

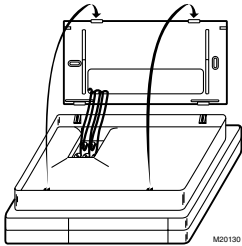
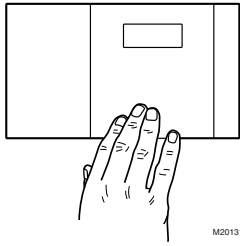

Fig. 12



- Align the tabs at the **top** of the thermostat with the tabs at the **top** of the mounting plate (Fig. 11).
- Press the lower edge of the case to latch the bottom of the thermostat (Fig. 12).

## Step 7. Install the batteries

Fig. 13

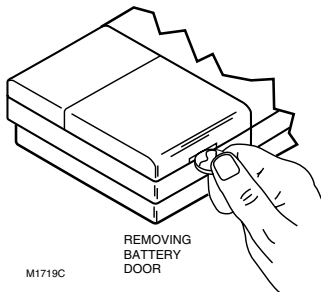

**IMPORTANT:** Batteries must be installed for programming and operation of the thermostat and heating/cooling system. Honeywell recommends using Energizer® batteries.

- Make sure that the System switch is set in the OFF position.
- Using a coin, open the battery door as shown in Fig. 13.
- Install the batteries.  
Make sure that the positive and negative terminals are oriented correctly as marked inside the battery case.
- Replace the battery door.
- Remove the clear plastic label from the digital display.

Fig. 14

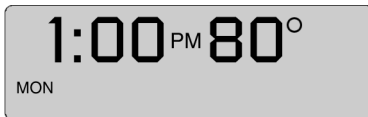

### ✓ Check your progress

When the batteries are installed correctly, the digital display flashes all entries once, then begins to flash a default time and the current temperature (Fig. 14). The flashing continues until you begin to program the thermostat.

You are now ready to program the thermostat. Go to page 12.



## Special wiring instructions

### A clock thermostat with C or C1 terminals

A clock thermostat has one or two extra wires attached to the C or C1 terminals that allow the clock to operate. These wires are not used during the installation of your new 3300 thermostat and must be insulated from each other to avoid damaging your electrical circuit.

- a. Make sure that power to the heating/cooling system is **turned off**.
- b. Locate the wires that are connected to the clock terminals marked C or C1.
- c. As you disconnect the wires, do not allow these wires to touch.
- d. Wrap the wires **separately**, using electrical tape to insulate the wires.
- e. Place the wires where they will not interfere with the operation of the new thermostat. You will not connect these wires to your 3300 thermostat.
- f. Continue with the installation as instructed on page 4 at step 2e.

### Six or more wires

If your old thermostat has six or more wires (excluding clock wires attached to the C or C1 terminals), your heating/cooling system is most likely a variation of a heat pump or multistage system. Your 3300 thermostat will **NOT** work with such systems and should be returned to the place of purchase. See the compatibility table on page 2 for information about which programmable thermostat **WILL** work with your system.

### Three thermostat wires

If you have three wires for heating only and can operate the fan using the old thermostat's fan switch, the 3300 thermostat will work with your system. Continue the installation procedure on page 4, step 2e.

If you have a three-wire heating-only system and cannot operate the fan using the old thermostat's fan switch, the 3300 thermostat will probably **NOT** work with your system. Contact your heating contractor for installation assistance.

### Wires that are not connected to the old thermostat

If there are extra wires that do not connect to your old thermostat, do not label them. You will not connect these wires to your new thermostat. Tape off the wires with electrical tape and place them where they will not interfere with the operation of the new thermostat. Continue the installation procedure on page 4, step 2e.

## Five wires connected to the old thermostat

Your new thermostat has a factory-installed metal jumper between the R and Rc terminals (Fig. 15). Remove the jumper before wiring the R and Rc terminals.

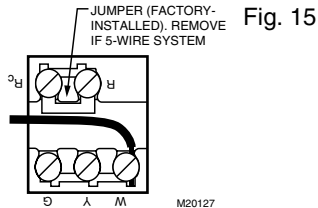

## Old thermostat terminals that do not match new thermostat terminals

Use the table below to wire the new thermostat.

Old thermostat terminal	Connect to new thermostat terminal	Description
R, RH, 4, V	R*	Power
Rc, R	Rc*	Power for cooling
W, W <sub>1</sub> , H	W	Heat
Y, Y <sub>1</sub> , M	Y	Cooling
G, F	G	Fan
O	Do not continue installation	Changeover in cool (O terminal) or changeover in heat (B terminal). You have a single stage heat pump or zoning system. See page 2 for an alternate thermostat model.
B		
C, X, B	Do not connect	Transformer common.
W <sub>2</sub> , H <sub>2</sub>	Do not continue installation.	Second stage heat (W <sub>2</sub> , H <sub>2</sub> ) or second stage cooling (Y <sub>2</sub> ). You have a multistage heating/cooling system. See page 2 for an alternate thermostat model.
Y <sub>2</sub>		

\*Remove factory-installed jumper between R and Rc terminals in 5-wire systems.

# Programming

## Faceplate illustration and descriptions

Fig. 16

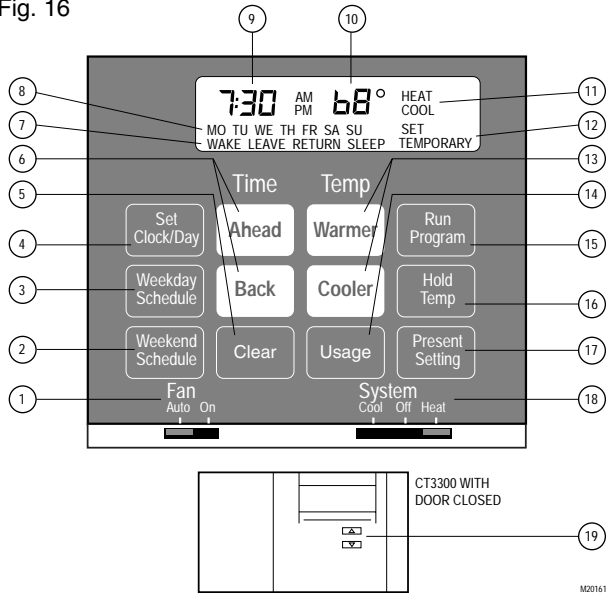







### Descriptions

- 1 Fan switch—Selects automatic or continuous fan operation (page 17).
- 2 Weekend Schedule—Initiates programming of the weekend heating or cooling schedule (page 15).
- 3 Weekday Schedule—Initiates programming of the weekday heating or cooling schedule (page 14).
- 4 Set Clock/Day—Sets the clock and day (page 12).

### Descriptions, continued

- 5 Clear—Cancels the currently displayed program (page 20) and clears the usage counter (page 21).
- 6 Time Ahead and Back—Sets the time ahead and back (page 12).
- 7 Program periods—Current program period or period being programmed (page 13).
- 8 Day—Current day or day being programmed.
- 9 Time—Current time or program time.
- 10 Temperature—Room or programmed temperature.
- 11 HEAT/COOL—Indicates if the heating schedule or the cooling schedule is running or being programmed.
- 12 TEMPORARY—Displays when a temporary override is made to the program (page 19).
- 13 Temp Warmer and Cooler—Raises or lowers the temperature (page 14).
- 14 Usage—Displays how long the heating/cooling system has been running (page 21).
- 15 Run Program—Returns thermostat to operating mode.
- 16 Hold Temp—Holds a selected temperature (page 19).
- 17 Present Setting—Displays the temperature setting for the current program period (page 20).
- 18 System switch—Selects Cool, Off, Heat (page 18).
- 19 Arrow buttons—Allow you to temporarily change the temperature without opening the faceplate door (page 19).

## Step 1. Set the current time and day

- a. Press  once.  
The time is displayed (Fig. 17).
- b. Press and hold  or  until the current time is displayed.
- c. Press  again.  
The day is displayed (Fig. 18).
- d. Press and hold  or  until the current day is displayed.
- e. Press  once.  
The current time and day and the current temperature are displayed (Fig. 19).

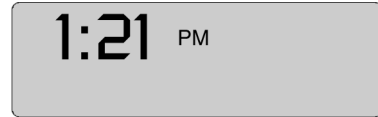

Fig. 17

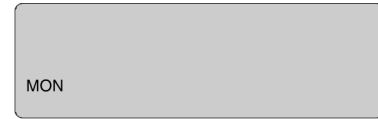

Fig. 18



Fig. 19

## Step 2. Learn about the programming features

Your CT3300 thermostat allows you to program schedules for both a heating season and a cooling season.

- During the heating season, you will want to set the normal room temperature higher and the energy-saving temperature lower.
- The reverse is true during the cooling season—the normal room temperature will be lower and the energy-saving temperature higher.

For each season, you can set up to four program periods for the weekdays (Monday–Friday), and up to two program periods for the weekends (Saturday and Sunday). The program periods are defined on the next page.

Program period	Description	When available
WAKE	The time when you get up and get ready to leave your home. You can set the system at a comfortable temperature for this period.	Weekdays and weekend
LEAVE	The time when you are regularly away from home. You can set an energy-saving temperature for this period.	Weekdays only
RETURN	The time between returning home and going to bed. You can set the system at a comfortable temperature for this period.	Weekdays only
SLEEP	The time when you are sleeping. You can set an energy-saving temperature for this period.	Weekdays and weekend

### Programming tips

- You do not need to program times and temperatures for all program periods.  
If you decide not to program your thermostat, it will automatically control heating at 68°F (20°C) and cooling at 78°F (26°C), 24 hours a day.  
If you decide not to program weekend schedules, the temperature that is programmed for the weekday SLEEP schedule will remain in effect until the next program period, which begins on Monday morning.
- The temperatures cannot be set any higher than 88°F (31°C) or any lower than 45°F (7°C).
- When pressing the buttons, use the ball of your finger or a soft pencil eraser. Use of sharp fingernails or pencil points can damage the keypad.
- If you make an error at any time during programming, press **Run Program**. Then press **Weekday Schedule** or **Weekend Schedule** until you reach the program period where you left off.

### Step 3. Program the heating schedule

- a. Write in the times and temperatures that you want to program for your heating schedule.

Heating Schedule	Program period	WAKE	LEAVE	RETURN	SLEEP
Suggested Settings	Time	6:00 AM	8:00 AM	6:00 PM	10:00 PM
	Temp	70°F (21°C)	62°F (16.5°C)	70°F (21°C)	62°F (16.5°C)
Weekday (Mon–Fri)	Time				
	Temp				
Weekend (Sat–Sun)	Time				
	Temp				

- b. Set the System switch to HEAT.

- c. Press **Weekday Schedule** once.

A blank schedule is displayed (Fig. 20).



Fig. 20

- d. Set the Monday–Friday WAKE time by pressing **Ahead** or

**Back** until the desired time is displayed (Fig. 21).

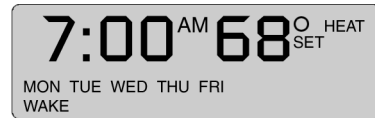

Fig. 21

- e. Set the Monday–Friday WAKE temperature by pressing

**Warmer** or **Cooler** until the desired temperature is displayed.

- f. Press **Weekday Schedule** to display a blank schedule for the next program period (Fig. 22) and repeat steps d. through f. for each weekday program period.

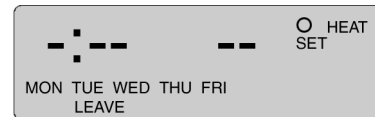

Fig. 22

g. Press **Weekend Schedule** until the weekend schedule is displayed (Fig. 23).



Fig. 23

h. Set the Saturday and Sunday WAKE time by pressing **Ahead**

or **Back** until the desired time is displayed.

i. Set the Saturday and Sunday WAKE temperature by pressing

**Warmer** or **Cooler** until the desired temperature is displayed (Fig. 24).

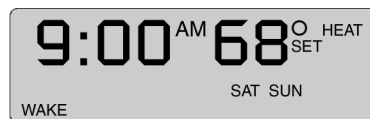

Fig. 24

j. Press **Weekend Schedule** again to display a blank schedule for the SLEEP program period and repeat steps h. through j. to set the program.

**Run Program**

## Step 4. Program the cooling schedule

a. Write in the times and temperatures that you want to program for your cooling schedule.

Cooling Schedule	Program period	WAKE	LEAVE	RETURN	SLEEP
Suggested Settings	Time	6:00 AM	8:00 AM	6:00 PM	10:00 PM
	Temp	78°F (25.5°C)	85°F (29.5°C)	78°F (25.5°C)	82°F (28°C)
Weekday (Mon–Fri)	Time				
	Temp				
Weekend (Sat–Sun)	Time				
	Temp				

- b. Set the System switch to COOL.
- c. Repeat steps 3c. through 3k. to program the weekday and weekend cooling schedule.

## Step 5. Check out the system

### Verify that your heating system works

- a. Set the System switch to HEAT and the Fan switch to AUTO.
- b. Press **Warmer** until the setting is 10°F (6°C) above room temperature (Fig. 25).  
Your heating system should start and the fan should run after a short delay.
- c. Press **Cooler** until the setting is 10°F (6°C) below room temperature.  
Your heating system should shut off.

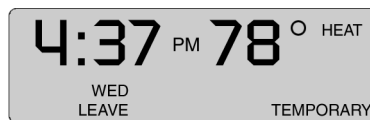

Fig. 25

### Verify that your cooling system works

**IMPORTANT:** To avoid damaging the compressor in the air conditioner, do not operate the cooling system when the temperature outdoors is below 50°F (10°C).

- d. Set the System switch to COOL and the Fan switch to AUTO.
- e. Press **Cooler** until the setting is 10°F (6°C) below room temperature (Fig. 26).  
Your cooling system and fan should start.  
**Note:** When the cooling setting is changed, the thermostat may delay up to 5 minutes before turning on the air conditioner. This delay protects the compressor.

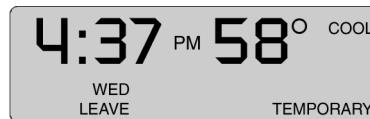

Fig. 26



- f. Press **Warmer** until the setting is 10°F (6°C) above room temperature.  
Your cooling system and fan should stop.
- g. Set the System switch to OFF and the Fan switch to AUTO.  
The cooling system and fan should be off.

## Operation

### Change the clock for Daylight/Standard Time

- a. Press **Set Clock/Day** once.  
The time is displayed.
- b. Press and hold **Ahead** or **Back** until the correct time is displayed.
- c. Press **Run Program** once.  
The current time and day and the current temperature are displayed.

### Set the Fan and System switches

The switches on the bottom of the thermostat faceplate (Fig. 16 page 11) control the operation of your fan and the heating and cooling system. Set the Fan switch first and then set the System switch.

Switch	Setting	Result
Fan	Auto	A single-speed fan turns on automatically with the air conditioner or furnace. A two-speed fan usually runs on high with the air conditioner and on low with the furnace. Auto is the normal setting for most homes.
	On	The fan runs continuously. Use this setting for improved air circulation during special occasions or for more efficient air cleaning.  <b>Note:</b> In a heat-only system, the fan runs continuously only if the fan wire has been connected to the G terminal on the back of the thermostat.

Switch	Setting	Result
System	Cool	The thermostat controls your air conditioning system.
	Off	Both the heating and air conditioning systems are off.
	Heat	The thermostat controls your heating system.

## Replace the batteries

As the batteries run low, your thermostat shows the following in the digital display:

If you see:	Batteries are:	You should:
Flashing “bAt Lo”	Low	Replace the batteries as soon as possible, within the month.
Steady “bAt Lo”	Almost dead	Replace the batteries immediately. Your heating/cooling system is not operating.
Blank display	Dead	Replace the batteries immediately. Your heating/cooling system is not operating.

- Make sure that the System switch is set in the OFF position.
- Open the battery door.
- Press on the left side of the batteries to remove them.
- Install the new batteries.

Make sure that the positive and negative terminals are oriented correctly as marked inside the battery case.

**Note:** If you insert the new batteries within 20–30 seconds of removing the old ones, you will not have to reprogram the thermostat. However, if the display is blank, the batteries are dead or incorrectly installed and you will have to reprogram. See page 12 to begin reprogramming.

- Close the battery door and set the System switch to HEAT or COOL.



**Note:** If “bAt Lo” continues to display after replacing the batteries, set the System switch to OFF, insert the batteries backwards, wait for five to ten seconds, and return the batteries to their correct orientation. Then see page 12 to begin reprogramming.

**IMPORTANT:** Replace the batteries once a year to prevent the heating/cooling system from shutting down due to lack of battery power in the thermostat. If you are leaving home for longer than a month, change the batteries before leaving to prevent the system from shutting down due to lack of power.

## Override the program settings

**Note:** Make sure the System switch is set to either HEAT or COOL before making any changes to the schedule.

### Change the temperature temporarily

Press  or  until the desired temperature is displayed.

The TEMPORARY indicator is displayed indicating that the change is temporary (Fig. 27).

**Note:** A temporary change to the temperature lasts for the current program period only. The heating/cooling schedule that you programmed resumes when the next scheduled program period is reached. To cancel the temporary change before the next scheduled program period, press .

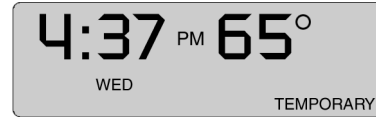



Fig. 27

### Hold a temperature indefinitely

Use the Hold Temp feature when you want to maintain a constant temperature indefinitely, such as when you go on vacation.

- a. Press .  
“HLd” is displayed (Fig. 28).

- b. Press  or  until the desired temperature is displayed.

The display shows the SET temperature for a few seconds and then resumes reading the current room temperature.

**Note:** To cancel the hold, press .



Fig. 28

## Check the current programmed temperature

Press **Present Setting** to display the temperature that is programmed for the current program period. The SET indicator displays briefly along with the programmed temperature (Fig. 29). The display then returns to the room temperature.

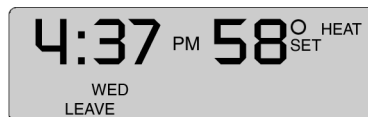

Fig. 29

## Check programs

Press **Weekday Schedule** repeatedly to display the times and temperatures that you programmed for the weekdays (Monday–Friday).

Press **Weekend Schedule** repeatedly to display the programmed times and temperatures for the weekend (Saturday and Sunday).

Press **Run Program** to resume the program.

## Cancel a program

a. Press **Weekday Schedule** or **Weekend Schedule** until the desired program is displayed (Fig 30).

b. Press **Clear**.  
A blank program schedule is displayed and the program is canceled (Fig. 31).



Fig. 30

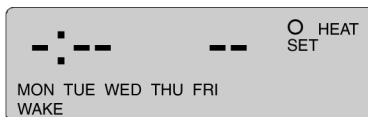

Fig. 31

## Check how long heat/air conditioning has been running

To display the length of time that the heat or air conditioning has been running:

- Since 12:00 AM today, press **Usage** once (Fig. 32).
- Since 12:00 AM yesterday, press **Usage** twice (Fig. 33).
- Since installation or since the last time you reset the cumulative usage counter (see below), press **Usage** three times.

## Reset the cumulative usage counter to zero

To clear the cumulative usage counter and start over at zero hours:

- Press **Usage** three times to display the cumulative reading.
- Press **Clear** to set the counter to zero (Fig. 34).
- Press **Run Program**.

## Change a program permanently

Follow the steps for programming the heating schedule or programming the cooling schedule on pages 14 and 15.



Fig. 32



Fig. 33

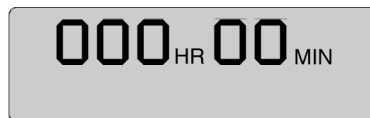



Fig. 34

## Frequently asked questions

If...	Then...
Display will not come on	<ul style="list-style-type: none"><li>• Make sure the batteries are fresh and installed correctly.</li><li>• Set the System switch to OFF. Remove the batteries and then insert them backwards for five to ten seconds to reset the thermostat. Replace the batteries correctly. The display should come on.</li></ul>
Temperature display will not go lower than 45°F (7°C) or higher than 88°F (31°C) during programming	<ul style="list-style-type: none"><li>• You have reached the temperature limit. The setting range is 45°F–88°F (7°C–31°C).</li></ul>
Display shows flashing or steady “bAt Lo”	<ul style="list-style-type: none"><li>• The batteries are low; replace them as soon as possible. See page 18 for instructions.</li><li>• If “bAt Lo” continues to display after replacing the batteries, set the System switch to OFF and insert the batteries backwards for five to ten seconds. Then replace the batteries correctly. The display should come on.</li></ul>
Temperature change occurs at the wrong times	<ul style="list-style-type: none"><li>• Check the program times for the period in question. Be sure that AM and PM indications are correct. Make sure the current day and time are correct. Reprogram if necessary.</li></ul>
Heating will not come on	<ul style="list-style-type: none"><li>• Check that the System switch is set to HEAT.</li><li>• Check the system fuse or circuit breaker and replace or reset if necessary.</li><li>• Check for correct wiring and good connections.</li><li>• If display is blank or displays “bAt Lo,” install fresh batteries.</li><li>• Allow time for the furnace to heat up and the fan to come on before checking for heat at the register.</li><li>• If the temperature setting is higher than the current room temperature and the SYSTEM ON arrow is displayed, the thermostat is operating correctly. Contact a heating contractor for assistance.</li></ul>

If...	Then...
Cooling will not come on	<ul style="list-style-type: none"> <li>• Check that the System switch is set to COOL.</li> <li>• Check the system fuse or circuit breaker and replace or reset if necessary.</li> <li>• Check for correct wiring and good connections.</li> <li>• If display is blank or says “bAt Lo,” install fresh batteries.</li> <li>• The thermostat has a built-in time delay on cooling. Allow 5 to 10 minutes after changing the setting before the air conditioner starts.</li> <li>• If the temperature setting is lower than the current room temperature and the SYSTEM ON arrow is displayed, the thermostat is operating correctly. Contact an air conditioning contractor for assistance.</li> </ul>
The house is too warm or too cool	<ul style="list-style-type: none"> <li>• Press  to check the current temperature setting.</li> <li>• If desired, change the temperature setting. See page 19 for instructions.</li> </ul>
The furnace cycles too frequently or the system cycle length is too short or too long	<ul style="list-style-type: none"> <li>• Adjust the screws on the back of the thermostat as instructed on page 7.</li> </ul>
The thermostat’s current setting does not match the displayed room temperature to within plus or minus 1°	<ul style="list-style-type: none"> <li>• Plug the wiring hole in the wall behind the mounting plate with insulation to prevent drafts that might adversely affect thermostat operation.</li> <li>• Be aware that it is normal for the current setting and the displayed room temperature to differ on occasion.</li> <li>• During recovery from setback or setup, setting and displayed room temperatures may differ for up to 30 minutes after recovery period.</li> </ul>

## Customer assistance

For all questions concerning this thermostat, please read and follow the instructions. If you need additional assistance, call Honeywell Customer Relations at 1-800-468-1502, Monday–Friday, 7:00 AM–5:30 PM Central Time, or visit us at [www.honeywell.com/yourhome](http://www.honeywell.com/yourhome). Before you call, please have the following information available:

- Thermostat model number and serial code (located under the battery cover)
- Type of heating/cooling system (hot water, warm air, oil, gas, etc.)
- Number of wires connected to the thermostat

**NOTICE:** This equipment is a Class B digital apparatus, which complies with Canadian Radio Interference Regulations, CRC c.1374.

## Limited 1-year warranty

Honeywell warrants this product, excluding battery, to be free from defects in the workmanship or materials, under normal use and service, for a period of one (1) year from the date of purchase by the consumer. If, at any time during the warranty period, the product is defective or malfunctions, Honeywell shall repair or replace it (at Honeywell's option) within a reasonable period of time.

If the product is defective,

- (i) return it, with a bill of sale or other dated proof of purchase, to the retailer from which you purchased it, or
- (ii) package it carefully, along with proof of purchase (including date of purchase) and a short description of the malfunction, and mail it, postage prepaid, to the following address:

Honeywell Inc. USA  
Dock 4 — MN10-3860  
1885 Douglas Drive North  
Golden Valley, MN 55422-3992

Honeywell Canada:  
Honeywell Limited/Honeywell Limitée  
35 Dynamic Drive  
Scarborough, Ontario M1V 4Z9

This warranty does not cover removal or reinstallation costs. This warranty shall not apply if it is shown by Honeywell that the defect or malfunction was caused by damage which occurred while the product was in the possession of a consumer.

Honeywell's sole responsibility shall be to repair or replace the product within the terms stated above. HONEYWELL SHALL NOT BE LIABLE FOR ANY LOSS OR DAMAGE OF ANY KIND, INCLUDING ANY INCIDENTAL OR CONSEQUENTIAL DAMAGES RESULTING, DIRECTLY OR INDIRECTLY, FROM ANY BREACH OF ANY WARRANTY, EXPRESS OR IMPLIED, OR ANY OTHER FAILURE OF THIS PRODUCT. Some states do not allow the exclusion or limitation of incidental or consequential damages, so this limitation may not apply to you.

THIS WARRANTY IS THE ONLY EXPRESS WARRANTY HONEYWELL MAKES ON THIS PRODUCT. THE DURATION OF ANY IMPLIED WARRANTIES, INCLUDING THE WARRANTIES OF MERCHANTABILITY AND FITNESS FOR A PARTICULAR PURPOSE, IS HEREBY LIMITED TO THE ONE YEAR DURATION OF THIS WARRANTY. Some states do not allow limitations on how long an implied warranty lasts, so the above limitation may not apply to you.

This warranty gives you specific legal rights, and you may have other rights which vary from state to state.

If you have any questions concerning this warranty, please write our Customer Relations Center, Honeywell Inc., 1885 Douglas Dr. N., Golden Valley, MN 55422-3992, or call 1-800-468-1502, Monday–Friday, 7:00 a.m. to 5:30 p.m., Central Time. In Canada, write Retail Products ON30 Honeywell Limited/Honeywell Limitée, 35 Dynamic Drive, Scarborough, Ontario M1V 4Z9.

---

### Home and Building Control

Honeywell  
1985 Douglas Drive North  
Golden Valley, MN 55422Z

### Home and Building Control

Honeywell Limited–Honeywell Limitée  
35 Dynamic Drive  
Scarborough, Ontario  
M1V 4Z9