

APRILAIRE HUMIDIFIERS MODELS 350 AND 360
SELF CONTAINED — INDEPENDENT SERIES

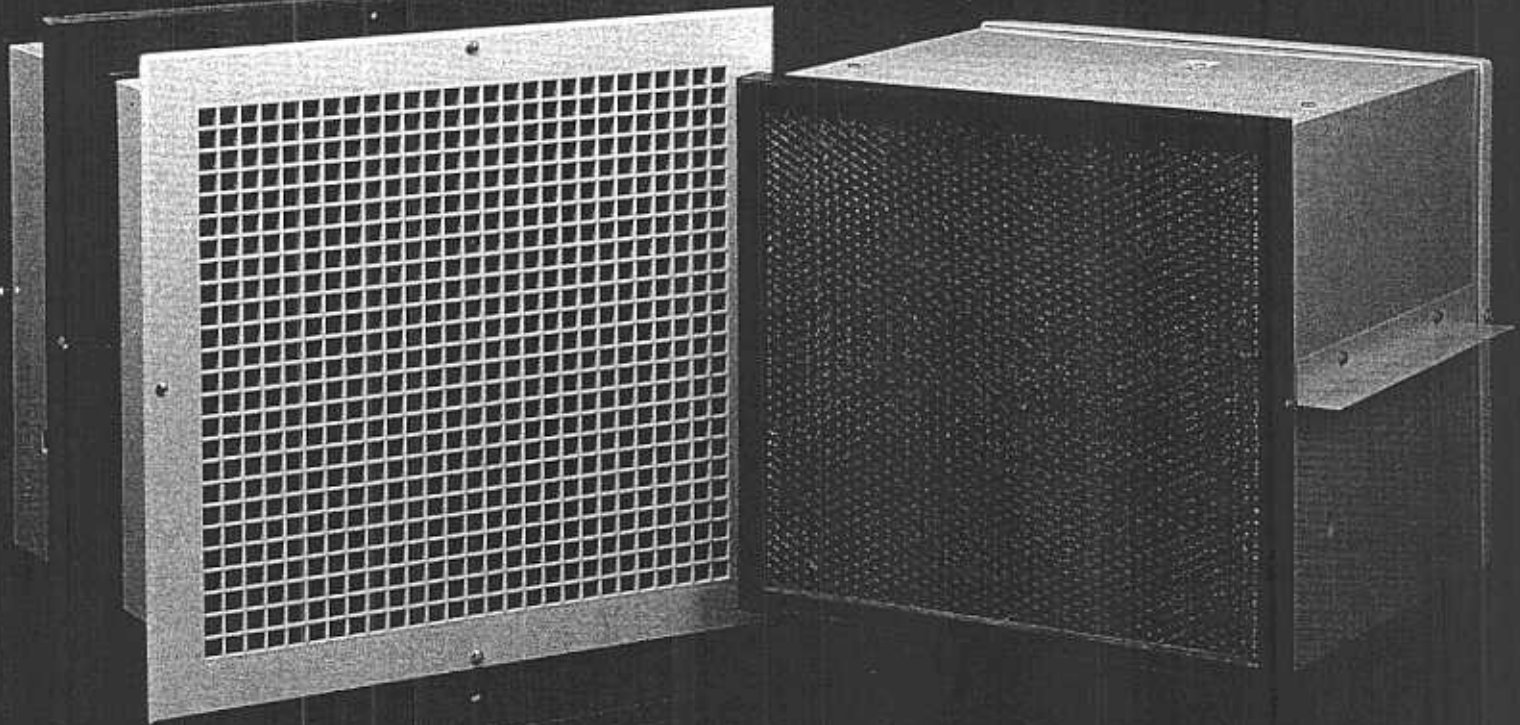

Aprilaire[®] HUMIDIFIERS

Residential — Condominium — Town Houses
Use With Any Type Heating System,
Including Steam, Hot Water
Installs Easily — Quickly
Automatic Humidistat Controlled
High Capacity — Minimum Maintenance

Dry Air Difficulties



Relative humidity is the percentage of moisture in the air compared to its maximum capability to hold moisture under the same conditions. 70 degree air can hold more than 12 times as much moisture as 10 degree air. Outside air at 10 degrees and 70 percent relative humidity drops to 7 percent relative humidity when heated to normal room temperature without other internal sources of moisture, such as cooking, laundry, showers, etc.

That's only a fraction of the humidity recommended for the average heated apartment or condo, and it's this "desert dryness" that makes you feel uncomfortable and takes moisture from your home, furnishings — even you and your family. The recommended indoor relative humidity is 35% and up to 45% in warmer climates or where special construction prevails — and not all humidifiers have the capacity to reach these levels.

Doctors often times have mentioned dry air as one of the causes for nose, throat, and other physical aggravations.

Heated air dries out and shrinks wood framing around doors and window frames. Gaps occur, permitting cold outside air infiltration. Heat loss and higher heating costs are often the result.

Heated, parched air causes separation of wood in floors, trim and furniture . . . excessive wear of fabrics and carpets . . . loss of piano tone quality . . . wall and ceiling cracks . . . plant damage and annoying static shocks are also a by-product of dry air.

Aprilaire®
WHOLE HOUSE HUMIDIFIERS
The best cure for dryness.



Proper humidity *reduces heating costs* by stopping wood shrinkage which reduces cold air infiltration around door and window frames.

In turn, you'll feel warm at lower temperatures. You can actually dial down your thermostat and still be comfortable.

In cases where excessive dry air has been the cause of physical aggravations, doctors have prescribed whole-house humidification.

Furnishings are protected with proper humidity too —reducing the damaging effects of heated, parched air upon everything from your wood floors to your plants.

Just set the dial.



A precision-made, accurately calibrated humidistat is always supplied with an Aprilaire humidifier. All you do is set the dial and reset when necessary, for the proper relative humidity.

Aprilaire® (self contained) series models 350 and 360

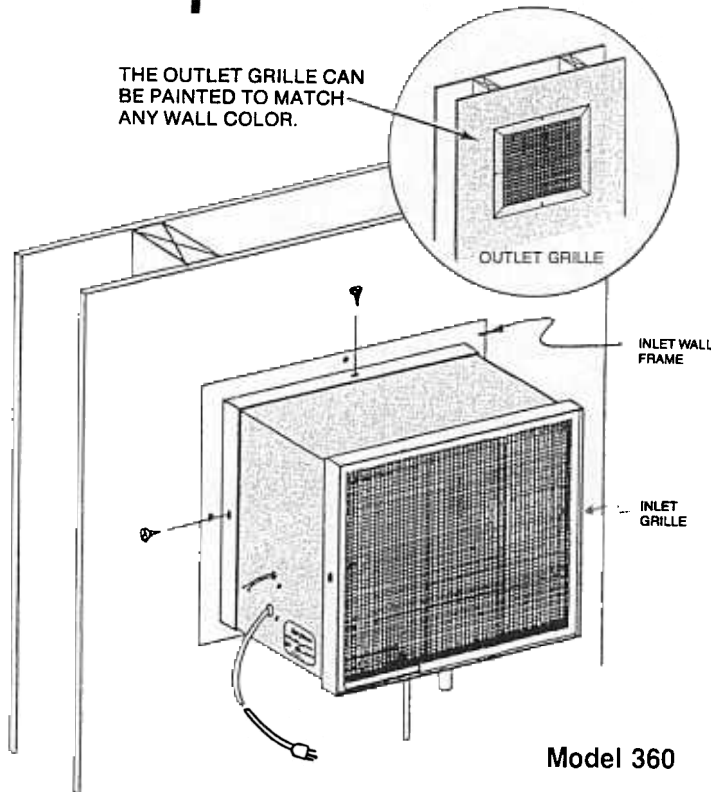

The Model 360 Aprilaire Humidifier is designed especially for any residence, condominium, town house, or apartment, regardless of the type heating system. It is installed through the wall without ductwork and is completely independent of the heating system. It is ideally suited for applications that have a humidity need, but require little heat, as well as installations where the air handling system is located where freezing conditions could occur. Also, the Model 360 will provide controlled humidity for the home with a heating system that has no space for a furnace mounted humidifier.

The Model 350 is designed especially for basement installations of hydronically heated homes, but is equally suitable for use with any other type heat. The unit can also be installed with or without ductwork in a closet, utility room, or heated crawl space. It has application where there may be a need for humidity, but infrequent need for heat. The Model 350 can be installed independent of the forced air heating system in a conditioned space to provide humidity as needed.

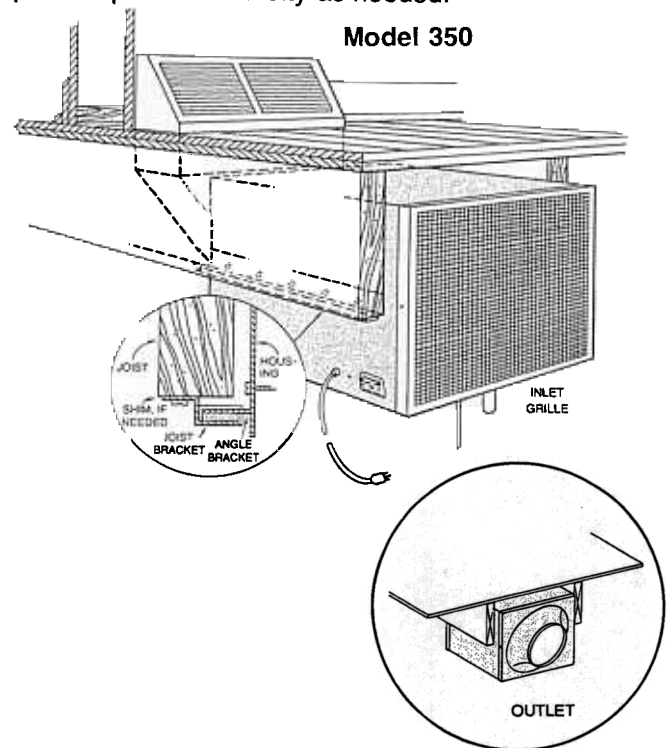

Both units are completely automatic—so you enjoy fingertip humidistat control. For the proper relative humidity in your home, you just set the factory-calibrated dial, and reset when necessary. The humidistat is usually installed on an inside wall in the living area.

Your Aprilaire humidifier means convenience: no water to carry, and no sumps or pumps to clean. The source of heat energy for evaporation is extracted directly from service hot water. There is no wasted energy because all the heat is extracted, so maximum efficiency has been accomplished. The flushing water moves most of the mineral scale left after evaporation out of the unit to drain. Humidified air is supplied through a single outlet duct or grille and because it is a vapor, equalizes throughout the home.

Unlike portable units, these centrally installed Aprilaire Humidifiers have high capacity and provide whole house humidification, automatically. There is no water to carry and no reservoir where water is allowed to stand between operation cycles.

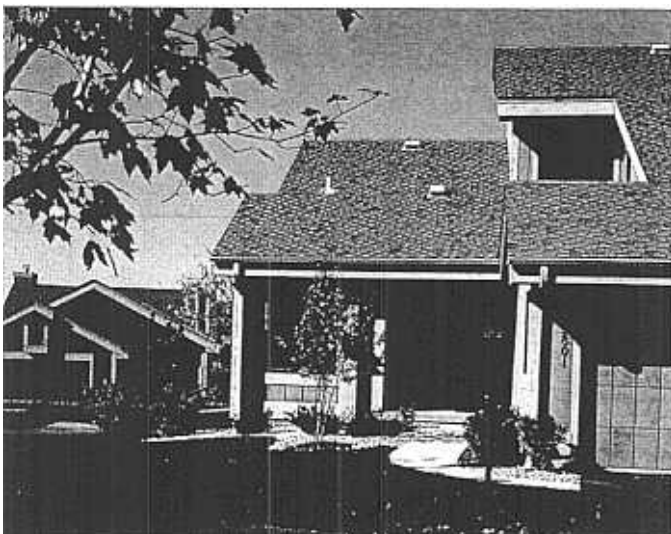

Specifications Models 350 and 360

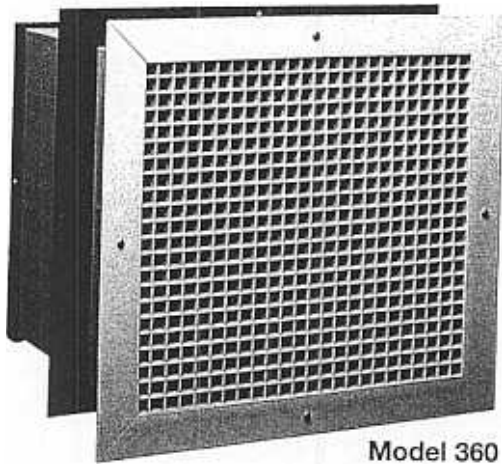

Model 360

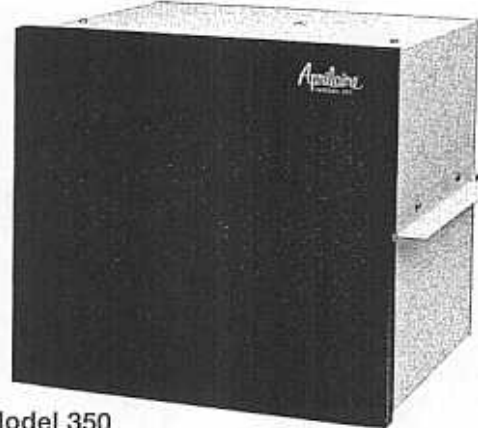

Model 350

Evaporative Capacity

0.5 gallons of water per hour using 140° service hot water at unit.

Volume of Home (cubic feet)

Loose home 9,000	2 air changes per hour
Average home 18,000	1 air change per hour
Tight home 36,000	½ air change per hour

Standard Rating Conditions

1. Outside air; 20°F and 70% R.H.
2. Inside air; 70°F and 35% R.H.
3. Internal moisture gain; 1 pound/hour
4. Continuous humidifier operation at 150 cfm
5. 140°F water

Size

Model 350	13¾" wide x 12¾" high x 15" deep
Model 360	13¾" wide x 12¾" high x 12½" deep

Wall frames and grille 16½" wide x 15½" high

Ductwork—Model 350 (not supplied)

7" dia. round ductwork to supply grille
Supply grille 50 square inches of free air minimum

Electrical Data

Model 350	120 volt 60 Hz. 0.9 amp
Model 360	120 Volt 60 Hz. 0.6 amp

Drain connection

½" I.D. plastic hose direct to drain fitting on unit

Also included: Humidistat and Saddle Valve

Shipping Weight 21 lbs.

There are Aprilaire Humidifiers available for all types of heating systems ...

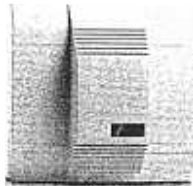

Model 760

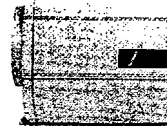

Model 550/560

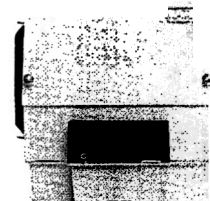

Model 445

To Help You Achieve Total Indoor Air Comfort ...

Ask your heating and air conditioning contractor about the famous Space-Gard® High Efficiency Air Cleaner, PerfectAire® Fresh Air Exchanger, and PerfectTemp® Zone Control System. These products, along with an Aprilaire® Whole House Humidifier will help you achieve Total Indoor Air Comfort in your home.



RESEARCH PRODUCTS CORPORATION

P.O. BOX 1467 • MADISON, WI 53701-1467

CALL 608/257-8801 • FAX 608/257-4357

Products for Better Indoor Air Quality™